



The Right Connection®

18 David Ogilvy
"Father of Advertising"

24 Pacific Northwest
Quirky Portland,
Youthful Seattle

32 The Crimean War
Modernizing Warfare

BOSS

FALL/WINTER 2017 ASIA/PACIFIC – SPRING/SUMMER 2017

CONNECTING TO INDUSTRY

In *Good* Time

From sundials to the atomic clock, humans have strived throughout history to gain a more accurate measure of the passing days of our lives



Real solutions for real challenges.

It's true that we have a broad product line available "anytime anywhere" to meet your everyday needs.

But we also design and manufacture just the right solutions to meet those special fluid transfer challenges where a standard product just won't do.

The difference boils down to commitment. It's called *Uncommon Excellence™* – and we've been living it for over a century.



The Right Connection®



ExD Series 'The Hawk' Centrifugal Pump

When pump efficiency is most important, Dixon Sanitary's ExD series of pumps will meet your requirements with ease. We offer four sizes with inlets from 1" to 4" and outlets from 1" to 2½".

Flows up to 500 GPM and the maximum head is 225 feet. A modular adapter and US patent pending shaft design provide increased flexibility and reduce purchase cost when changing motor frames. All pumps mount to standard C-Face motors and can be supplied with optional adjustable leg kits or mounted on a pump cart.

Visit dixonvalve.com to learn more.

Uncommon Excellence • Uncommon Excellence • Uncommon Excellence • Uncommon Excellence • Uncommon Excellence • Uncommon Excellence • Uncommon Excellence

BOSS

FALL/WINTER 2017
ASIA/PACIFIC –
SPRING/SUMMER 2017

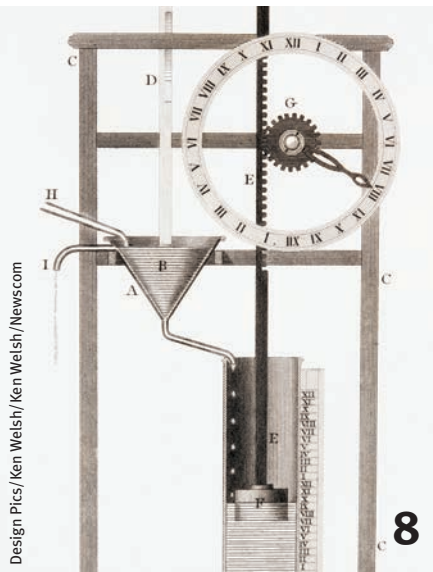

Design Pics/Ken Welsh/Ken Welsh/News.com



Photograph © Ogilvy & Mather, all rights reserved



freability/iStock/Getty Images Plus/Getty Images

FEATURES

8 IN GOOD TIME

From sundials to the atomic clock, humans have strived throughout history to gain a more accurate measure of the passing days of our lives.

By Allen Abel

18 THE MAN BEHIND THE BRAND

David Ogilvy, the tweedy, pipe-smoking Brit, became the “King of Madison Avenue.” But the primary brand he was selling was himself.

By David Holzel

24 THE PACIFIC NORTHWEST

Quirky and fun, this corner of the United States offers offbeat urban experiences and magnificent natural beauty.

By Sarah Achenbach

32 THE CRIMEAN WAR

A catastrophic collision of forces in the mid-19th century helped modernize warfare by introducing the telegraph, modern nursing methods and more.

By Eugene Finerman

DEPARTMENTS

6 PROFILE

George Cadbury: Sweet Reform

23 THE DIXON DRILLER

36 DIXON SPOTLIGHT

Dixon HTE: A Smooth Solution

38 HEALTH & FITNESS

A World of Pain: Migraines

40 INVENTIONS

The Internet



Photos by David Bohrer / National Assoc. of Manufacturers.

THE NEED FOR CIVILITY

On a Sunday afternoon this fall, I received an interesting phone call. I learned that Paul Ryan, Speaker of the U.S. House of Representatives, wanted to visit our plant during National Manufacturing Week, together with Congressman Andy Harris and Jay Timmons, CEO of the National Association of Manufacturers.

On October 5, the trio and their staff members came to Dixon to discuss tax reform and the need to help businesses compete and expand during a town hall meeting with our employees and a sit-down with senior staff.

Our employees enjoyed the Q&A with Speaker Ryan and were not shy with their questions. We were able to express our views regarding the need for changes in corporate tax rates if the United States of America is to be competitive in the global market. Speaker Ryan listened. He has a very easy way about him and that allowed for a friendly and productive dialogue.

If only the atmosphere in our nation's capital could follow suit. As I write this, we find our country at a critical juncture. The discord in Washington must stop. Disagreements are fine and necessary, but unfortunately too much of our public discourse has devolved into name-calling and discord, contributing to an overall lack of civility and integrity.

At Dixon, our mission states we are "working together to delight our customers." I would urge our political leaders to do the same.

Thanks for reading,

Dick Coorall



BOSS

FALL/WINTER 2017

ASIA/PACIFIC – SPRING/SUMMER 2017

Publisher
Dixon Valve & Coupling Company

Editor
Sue De Pasquale

Editorial Board
Richard L. Goodall, CEO, Dixon
Bob Grace, President, Dixon
Taylor Goodall, Vice President,
Distribution, Dixon
Scott Jones, Vice President, Sales &
Marketing, Dixon
Bill Harr, Global Marketing Director
Karen R. Hurless, Art Director
Charles Athey, Compliance Manager
Holly Langenfelder, Customer Service Manager

Editorial & Design
Mid-Atlantic Media

Director of Custom Media
Jeni Mann

Designer
Cortney Geare

Please submit address changes and requests for new subscriptions to:
Dixon Valve & Coupling Company
Attn: Marketing Department
800 High Street
Chestertown, MD 21620 USA
boss@dixonvalve.com
410-778-2000, ext. 1220
Fax: 800.283.4966

BOSS is produced three times a year by Dixon Valve & Coupling Company and Mid-Atlantic Custom Media. The acceptance of advertising does not constitute endorsement of the products or services by Dixon Valve & Coupling Company. The publisher reserves the right to reject any advertisement that is not in keeping with the standing or policies of Dixon Valve & Coupling Company. Copyright 2017, all rights reserved. Reproduction of any part of BOSS without written permission is prohibited.

Dixon Valve & Coupling Company
800 High Street
Chestertown, MD 21620
877-963-4966
Fax: 800-283-4966
www.dixonvalve.com

Email questions or comments about BOSS to:
boss@dixonvalve.com

ON THE COVER

baramee254/iStock/Getty Images Plus/Getty Images

JOIN US!



Sweet Reform

For George Cadbury, producing delicious chocolate was just the start

> IF YOU'RE A FAN OF CHOCOLATE, chances are good that you've probably munched on a Cadbury chocolate bar at some point in your life. Cadbury is the second largest confectionary brand in the world (after Wrigley's). Consumers in more than 50 countries enjoy Cadbury's Dairy Milk chocolate and other sweet temptations. The company's 180-plus years of success are largely linked to the discipline and benevolence of one man: George Cadbury.

While clearly a successful businessman, Cadbury was committed to more than producing great chocolate. A pioneering social reformer, he worked tirelessly to improve the living and working conditions of his employees, and the philanthropic ventures he established continue to enrich the lives of countless people today.

George Cadbury was born in 1839, in the English industrial city of Birmingham. His family was devoted to the Society of Friends, a Quaker denomination espousing

nonviolence, inner reflection and simplicity. Quakerism would become a guiding light for George—one that would inspire his work throughout his life.

George's father, John Cadbury, first started selling cocoa products at 93 Bull Street, Birmingham, in 1824.

The timing was fortuitous. The Cadbury's shop opened as chocolate consumption was on the rise in Britain. At this point, the chocolate bar so popular today had yet to be developed. Instead, most of the Cadbury's cocoa business consisted of "drinking chocolate"—a concoction of melted cocoa butter far richer than today's powdered hot chocolate.

John Cadbury's humble grocery quickly expanded into ever-larger factories. With the new facilities, production increased dramatically, and he enticed his customers with 16 varieties of drinking chocolate, as well as coffee and teas galore.

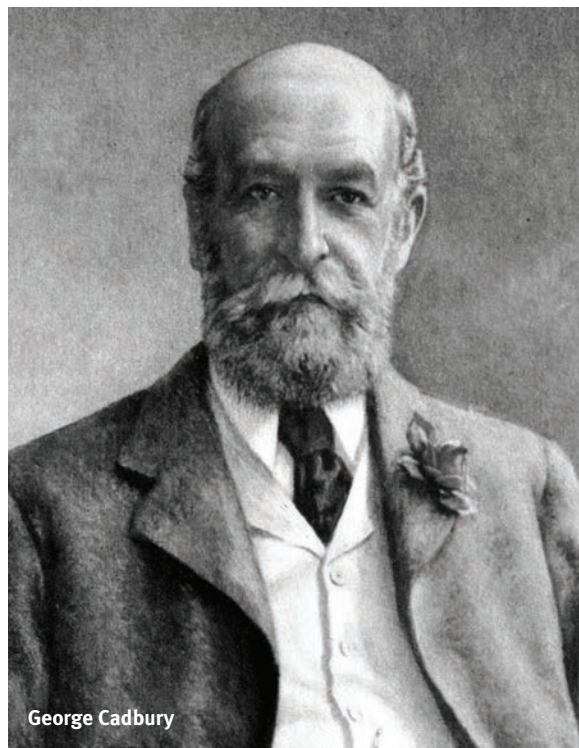

George Cadbury

Caters News/ZUMA Press/Newscom

Then, in 1855, personal tragedy struck. The death of John's sickly wife, Candia Cadbury, hit the family hard. John Cadbury fell into depression. Profits dived; the company suffered annual losses. Eventually, the elder Cadbury decided that it was time to turn the business over to his sons.

George and Richard Cadbury took over in 1861, hoping to breathe new life into the chocolate business. The two 20-something brothers were committed to working hard. "Their rescue of the ailing family business reads like a textbook example of the Victorian virtues of hard work and economy," writes historian Walter Stranz, who notes that the brothers toiled 12 hours a day, six days a week.

Before long, George Cadbury found success with the bold acquisition of a Dutch invention that pressed butter out of the cocoa, creating a pure and delicious cocoa essence. The brothers advertised their new product on London omnibuses, and the public



couldn't get enough. By 1870, the Cadbury Company could claim 200 employees. The firm was outgrowing its cramped urban confines.

The Cadbury brothers cast their eyes to the Birmingham suburbs, finding a suitable site at Bournville, 4 miles south. George plunged into designing a new factory. Within 10 years there, Cadbury's workforce exploded from 230 to 1,200.

Efficiently producing milk chocolate was a huge breakthrough. The Cadbury brothers used canal lines to directly link Bournville to the dairy farms of nearby Shropshire and Gloucestershire. The result of this expeditious shipping: Cadbury's famous "Dairy Milk" chocolate bar, which hit the market in 1905. (Sadly, Richard Cadbury did not live to see the debut of Dairy Milk. He died unexpectedly in 1899, at the age of 63.)

In tandem with the expansion of the chocolate business, George Cadbury was committed to bettering the welfare of his employees and their families. He believed that happy workers, living in pleasant and sanitary surroundings, would contribute to an

esprit de corps that would also be good for business.

By the 1890s, the city of Birmingham had started to intrude onto the 24-house neighborhood constructed by Cadbury when the company first moved to Bournville. To escape the creep of dingy urban slums, George Cadbury envisaged a 120-acre planned community. He wanted every Cadbury worker to dwell in a suburban cottage, replete with personal gardens, low rents and leafy green surroundings.

Bournville Village was founded in 1895. Unlike other communities designed by industrial reformers, Bournville Village was not a "company town." Laborers from other businesses were free to move in as well. In fact, during George Cadbury's lifetime, only 40 percent of the village's inhabitants were Cadbury employees.

To help promote his ideas about social reform, he purchased several newspapers. These provided a pulpit for him to lobby for improved working conditions for all workers and to share details of the social security program he had established at Cadbury Ltd.

CADBURY TODAY

Cadbury was acquired by Kraft Foods in February 2010 and two years later, Kraft split into two companies. Its confectionary business became Mondelez International, with Cadbury as a subsidiary. Today, Cadbury chocolate production continues at factories across the United Kingdom, including at Bournville, which is also home to Mondelez's Global Centre of Excellence for Chocolate Research and Development. Every new chocolate product created by Cadbury anywhere in the world starts its life at the Birmingham plant.

As the family business' fortunes grew, so did George Cadbury's commitment to philanthropy. Each summer, he hosted grand parties for 25,000 deserving inner-city children of Birmingham on his wooded estate. And he donated the building for the Royal Orthopaedic Hospital in Birmingham (which formed from the union of two hospitals and opened in 1909), where he made the rounds on Sunday mornings, leaving each patient with a Cadbury Dairy Milk chocolate bar.

Throughout his later years, George Cadbury's favored brand of philanthropy, in keeping with his Quaker faith that valued simplicity, was far from flashy. He savored quiet, direct contact with the people he served. And he passed down this philanthropic commitment to his two sons, who carried on the tradition as adults.

George Cadbury died on Oct. 24, 1922, at the age of 83. Through the thriving business that he and his brother created, and the Village Trust they founded, the Cadbury legacy lives on. ◀

The Cadbury factory in Bournville, Birmingham



Ian Yates/UppA/Photoshot/News.com





In *Good* Time

From sundials to the atomic clock, humans have strived throughout history to gain a more accurate measure of the passing days of our lives

BY ALLEN ABEL

The way William Shakespeare tells the tale, three noble Romans were walking down the Appian Way one day, discussing their plans to murder Julius Caesar, when their conspiratorial conversation was interrupted by the clanging of a bell.

“Peace! Count the clock,” demanded Brutus, which was a polite way of telling his brother-in-law Cassius to shut up and listen.

“The clock hath stricken three,” reported Cassius.

“Tis time to part,” announced Trebonius. And so exit they did.

But there is one problem with the words of the immortal Bard: In ancient Rome, there were no bell towers tolling

Caesar’s final hours on the Ides of March; in fact, there were no accurate mechanical clocks anywhere in the world in that period. As difficult as it may be for us to comprehend here in the third millennium, not until quite recently did anyone really know what time it was, nor did most folks even care. And today, even in an age when the most accurate atomic clock might lose only one second in 32 billion years, we still are struggling to understand what exactly time is.

In the modern world, time is a commodity to be saved or wasted, lost or borrowed, bided, spent or filled. We yearn to be on time for show time, we take time from work to make

time for our families, and we bite our nails when our favorite pastime goes into overtime.

No one knows why William Shakespeare, writing in 1599, inserted such a flagrant anachronism into one of his greatest works. But what is certain is that, throughout human history, the increasingly accurate measurement of what we call “time” has been both the parent and the child of technological innovations and cultural touchstones as varied as the passenger railroad, the swinging pendulum, the self-driving car, “dinner at 8,” “five o’clock shadow” and “traffic and weather together on the ones.”

Gear image: mladin61/E+/Getty Images



“
The ancient Egyptians and the Sumerians started dividing the day into 12 daylight hours and 12 night hours and that’s the beginning of hours,” explains Karen Carr.

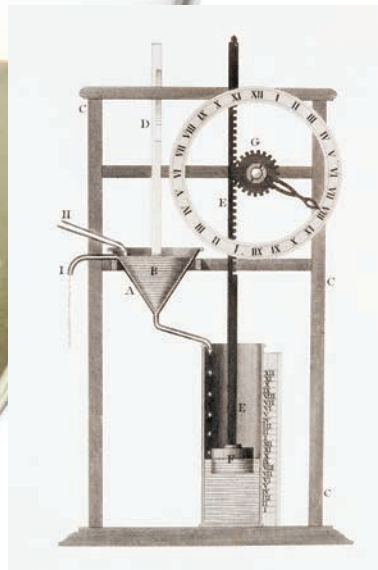

An ancient water-dripping clock, known as a clepsydra; Su Song’s clock tower, which introduced the escapement

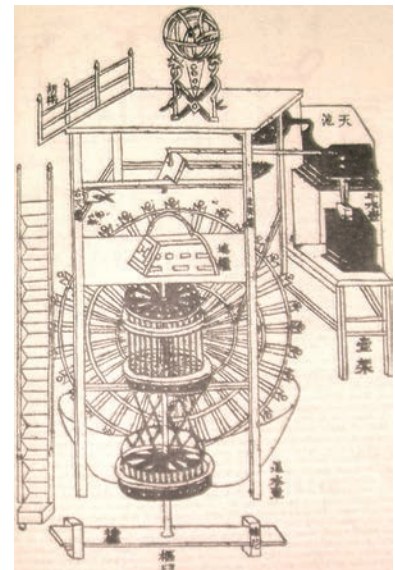

First Hours, Then Minutes

Sundials, dripping water, melting candles, pungent incense, burning oil, sand-filled “hourglasses”—all have been used since prehistoric times to divide the days of our lives into approximate fractions called hours, and, beginning late in the 17th century (with the invention of spring-wound mechanical clocks and watches), to subdivide those hours into minutes.

Two millennia ago, Shakespeare’s Gaius Trebonius wasn’t the only Roman in a rush. A mosaic found on the site of the ancient city of Daphne—and exhibited in New York City last year—shows a citizen anxiously hurrying past a public sundial, his toga flapping in his haste, with the inscription, “The ninth hour has caught up.” And that time—nine hours after sunrise, or what we would call 3 p.m. today—meant dinner time, not our fashionable 8 in the evening, since sundials obviously don’t work after dark.

“The ancient Egyptians and the Sumerians started dividing the

day into 12 daylight hours and 12 night hours and that’s the beginning of hours,” explains Karen Carr, professor emerita of history at Portland State University in Oregon, who has written extensively on ancient civilizations and their relationship to time. “They also used a 12-hour day in China, in Japan, in North Africa and East Africa. It spread very quickly.”

Why 12? “There are 12 moon cycles in a year, so they were already dividing the year into 12, so why not the day as well? It’s a good number, and that’s why we still use it today. One hour is not a long time—if you say you’re going to

Ancient Egyptian sundial





Dutch mathematician Christiaan Huygens, 1629-1695, is shown demonstrating his invention of the pendulum clock in this frieze at the Rijksmuseum in Amsterdam.

meet someone, you will probably wait for an hour before you give up," says Carr. She continues, "During the French Revolution, they tried to institute a 10-hour day, since they were already doing the meter and the gram, but it went nowhere and they went back to 12 and 24."

About midway between the lifetimes of Caesar and Shakespeare, Chinese technicians engineered a way to obtain precise—or at least more precise—measurements of the passage of time. The Song Dynasty polymath Su Song constructed a 40-foot-tall tower; inside,

36 buckets of water were filled, emptied, raised and lowered along an endless skein.

This was the ancient clepsydra—the water-dripping clock first known to be used by Babylonians as early as 1600 B.C.—uprooted by the addition of another world-changing Chinese invention: the escapement. This toothed gear ticked open and tocked shut at regular intervals as gravity drew the water buckets down along their chain.

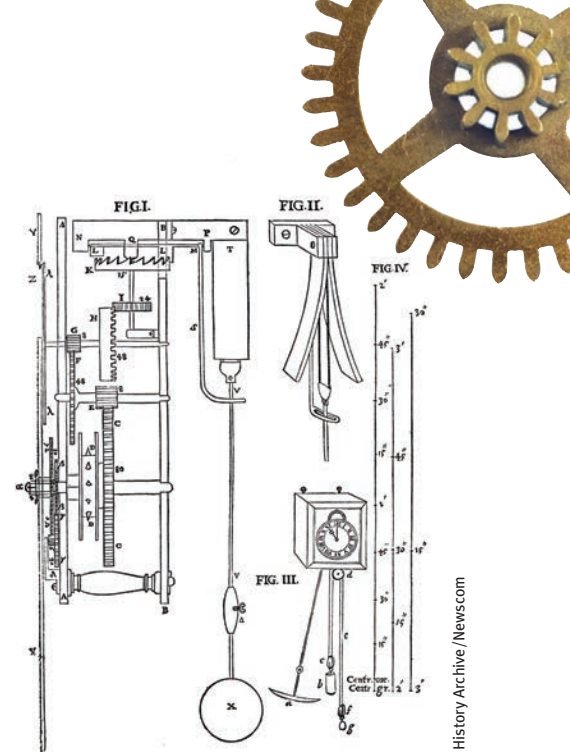

Design for a pendulum clock, by Christiaan Huygen

It was the escapement that finally divorced timekeeping from the sun.

Su Song's masterwork, which drove the wheels of an armillary sphere to measure and predict the movements of the heavenly bodies, was used mostly for astrological purposes, and was dismantled by the next ruling clan. But on the Arabian Peninsula, the rise of Islam—and its requirement that the faithful pray five times a day—made it necessary to announce the hours from lofty towers and to instill, in Carr's words, "the idea that telling time was a public responsibility."

In Christian Europe in the 13th century, the use of escapement mechanisms in clocks driven by falling weights led to the tolling of bells for each hour of the day and night. (These were the strokes that Shakespeare had Cassius count.) Some 300 years later, Galileo Galilei theorized that the regular motion of a swinging pendulum could be combined with an escapement gear to produce a clock capable of extreme (for the time) accuracy. Galileo died before a prototype could be built. But by 1700, Christiaan Huygens and his successors had succeeded in constructing a pendulum clock that gained or lost only 15 seconds a day.



Harrison H4 chronometer

https://commons.wikimedia.org/wiki/File:Harrison_H4_chronometer.jpg

CM Dixon Heritage Images/Newscom

John Harrison, a self-educated English carpenter and clockmaker, invented the marine chronometer, which could retain its accuracy for months or even years while at sea. He was awarded a government prize for its accuracy after sea trials.

or even years aboard a heaving ship in climates both arctic and tropical. The precise measurement of hours, minutes and seconds opened the globe to conquest and commerce, discovery and Darwin, intercontinental immigration and endless imperial war.

One of the keys to Harrison's model "H4" was a mainspring made from strips of both brass and steel that compensated for each other's expansion and contraction. He also fitted H4's pivots with tiny diamonds and rubies to reduce damage caused by friction—the "jeweled movement" that still is part of fine timepieces today.

"Technological innovation led to social changes, and social changes led to more technological innovation," says Noel Poirier, director of the National Watch & Clock Museum in Columbia, Pennsylvania. "Before the Industrial Revolution, the people who kept time were the people in power—the church, the town hall, the courthouse—so there is a power component to timekeeping

At the same time, the meaning of time also changed, instilling the idea that, as one Puritan English cleric put it, one must "use every minute as a most precious thing. Take it now or it's lost forever."

Power Play

In 1772, Englishman John Harrison finally conquered the ancient and vexing problem of determining longitude at sea by perfecting (to the satisfaction of King George III) a spring-powered "chronometer" that could retain its accuracy for months



What in the World?

Need to plan a meeting with a client living halfway around the world? Consult this online world clock to find the current time for cities all over globe—from Addis Ababa to Zagreb: www.timeanddate.com/worldclock/

Time zone clocks: olegganko/iStock/Getty Images Plus/Getty Images; Gear: robas/E+/Getty Images

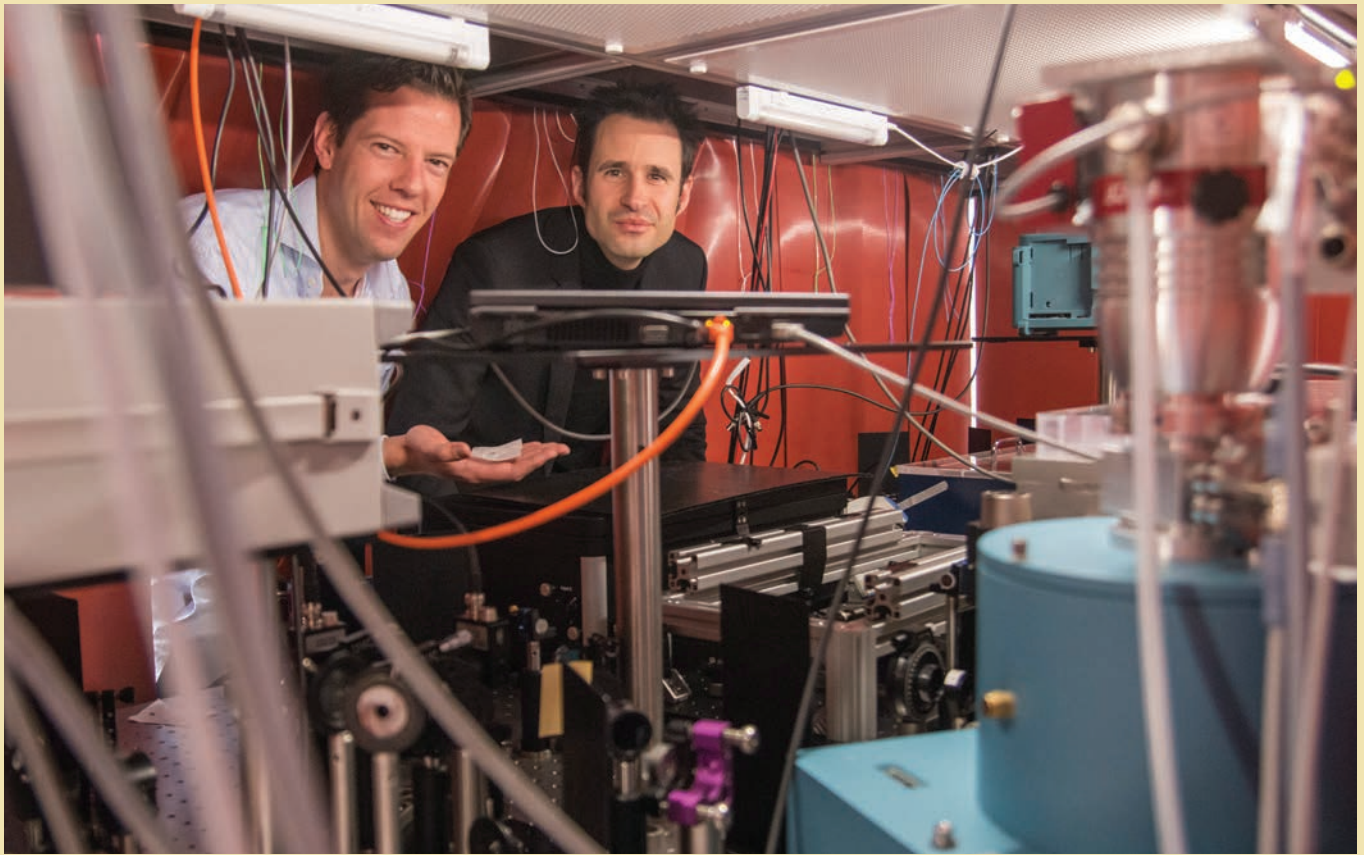

Vienna University of Technology

Simon Stellmar, left, and Thorsten Schumm, right, pose behind one of their laser set-ups at TU Vienna. The two are part of the European Union team that is working to construct a “nuclear clock.”



Vienna University of Technology

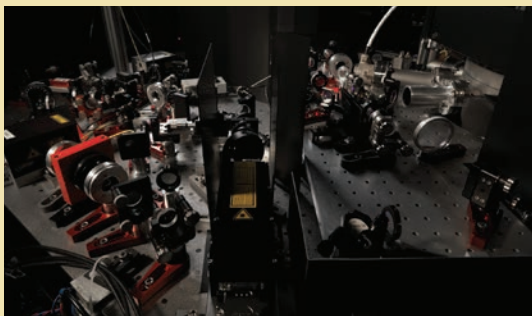

Physikalisch-Technische Bundesanstalt

Top: A ^{229}Th -doped crystal, which could form the center piece of one (out of many) possible realizations of a future nuclear clock. Below: Addition of a laser system to cool and manipulate the ions.

The Nuclear Clock

When is a single atom too big and a one-second deviation in 32,000,000,000 years not precise enough? When you’re trying to design an autonomous car that can squeeze itself into a tight parking spot, according to the European scientists who are striving to construct a “nuclear clock” that will be far more accurate than the current record-holder.

The “NuClock,” which is being funded by the European Union’s Future and Emerging Technologies Initiative, is a multinational quest to use lasers to excite vibrations within the nucleus of the element Thorium-239.

“Bonds within the nucleus are much tighter and the forces are much stronger than in the electron cloud,” explains Thorsten Schumm, a German-born physicist based in Vienna who is part of the EU team. “By finding the resonant frequency of the Thorium nucleus, we can make a clock that is 10 to 100 times more accurate than the best atomic clock today.

“This would enable us to make GPS accurate to within one centimeter, which is what you would need for a self-parking vehicle, and for research into the basic physics of the universe. This is the dream of the clock community.”

But there two major roadblocks, according to Schumm: Thorium is a short-lived, man-made, radioactive element of which only a few grams exist in the world. And the EU scientists have yet to find the precise frequency of its internal resonance: “a needle in the haystack problem.”

Asked when the first nuclear clock might be operational, Schumm says, “My answer is five years. But that also was my answer five years ago.”





“

In the 1700s and early 1800s, factories in England began to have clocks. They were paying people by the shift and by the hour and they didn't want the line to stop moving.”

that made access to knowing what time it was something that was limited to the wealthy or the powerful.

“The technology was so expensive that it limited access, and that technology became a status symbol, and it still is. A clock and then a watch became a family heirloom, a significant symbol of a family making it or not making it. Not until the mass production of clocks and watches in the 19th century did we put time back in the hands of individuals.”

“It is a totally capitalistic thing,” says Carr. “It was all driven by factories and railroads.” Most people around the world were still using flexible hours until the 19th century, but in the 1700s and early 1800s, factories in England began to have clocks. They were paying people by the shift and by the hour, and they didn't want the line to stop moving.

The situation was different in less developed countries and places with few factories and railroads, like Russia, Africa and Mexico, says Carr. Those regions continued to live on “agricultural time”: Workers were hired to bring in the harvest and were needed all day, from dawn to darkness, says Carr. “In countries where factories and trains came later, the concept of accurate time also came later, and maybe never reached the same importance.”

Until the invention of the telegraph in the 1840s, information could travel no faster than a running horse or a primitive, belching locomotive. But suddenly, a telegram sent from Chicago when the sun reached its highest point in the sky (the time known as “local



In a Second

One second used to be defined as 1/86,400 the length of a day. However, Earth's rotation isn't perfectly reliable. Tidal friction from the sun and moon slows our planet and increases the length of a day by 3 milliseconds per century. This means that in the time of the dinosaurs, the day was just 23 hours long.

Source: Discover magazine

noon”) would arrive, simultaneously, in Cleveland at 12:24 in the afternoon, and in St. Louis at 11:50 in the morning. Not until 1883 would the American government formally divide the continental United States into four fixed zones that chase the sun from Maine to California.

“Timekeeping, or being quote ‘on time,’ started to become very important to folks in the 19th century,” says Poirier. “That is when railroads were trying to synchronize their schedules so that trains weren't colliding on the same track. It became essential that it be on some kind of schedule.”





Of Quartz and Atomic Isotopes

In the 19th century, mass production, centered in Connecticut, lowered the price of a pocket watch to \$1 (about \$25 today), further democratizing time. But not until World War I, when wristwatches were intrinsic to coordinating infantry charges and artillery bombardments, did so-called “strap watches” catch on with the average man. “Vaudeville artists and moving-picture actors have utilized it as a ‘silly ass’ fad,” noted *The New York Times* in 1916, “but the objectors are now willing to concede the value of a bracelet watch for general outdoor life.”

By this time, Pierre Curie and other chemists had discovered that a crystal of quartz vibrates at a constant rate when excited by an electric current. Industrial-sized quartz clocks came into use before 1940, but it took another three decades before the electronics could be miniaturized to the size of a wristwatch. This innovation allowed the average Joe to carry the time to the fraction of a second, without worrying about winding, friction, temperature or waiting for the church bells to toll.

Yet even the quartz watch was not accurate enough for many. By the late 1960s, physicists had discovered that an atom of the isotope cesium-133, when excited by a laser at just the right frequency, will move to a measurably higher energy state at a rate of 9,192,631,770 times per second—no more, no less. This was the birth of the

atomic clock, the most accurate time-measuring instrument yet invented, with an emphasis on *yet* (see “The Nuclear Clock,” p. 13).

“There are actually two kinds of time,” notes John Lowe, deputy chief of the Time and Frequency Division of the National Institute of Standards and Technology in Boulder, Colorado. “One is, ‘What time is it right now?’ and we can calculate that with the best atomic clocks to about 10 to the minus-18th seconds, though we are working to improve that.

“The other is, ‘How long is one second?’ and that is what defines frequency and frequency is ubiquitous in our technological world, from the alternating current of 60 cycles per second in our wall sockets, to our cellphones. The entire telecommunications industry—the way

French chemist Pierre Curie and others discovered that a crystal of quartz vibrates at a constant rate when excited by an electric current, eventually making possible the quartz clock.

Spring Forward, Fall Back

Daylight Saving Time began as a joke by Benjamin Franklin, who proposed waking people earlier on bright summer mornings so they might work more during the day and thus save candles. It was introduced in the United Kingdom in 1917 and then spread around the world.

Source: Discover magazine



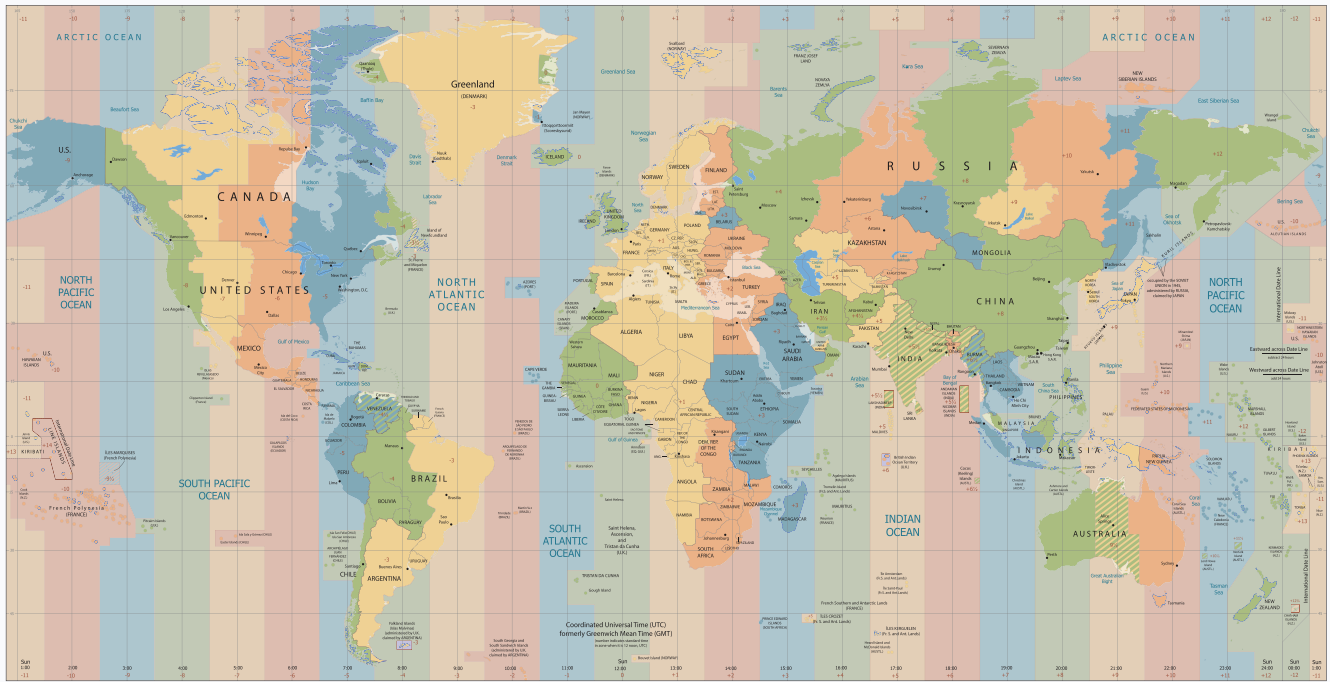

Pomogavev/iStock/Getty Images Plus/Getty Images

Today there are more than 24 time zones.

The Time Zone

During the 19th century, American railroads maintained many different time zones. Every city in the United States used a different time standard. Because each train station set its own clock, coordinating train schedules was difficult and confused passengers. To meet the demand of efficient rail transportation, four standard time zones for the continental United States were introduced on November 18, 1883.

Britain's involvement in setting its own standard time system for England, Scotland and Wales, contributed to the international consensus for global time zones in 1884. The Greenwich Meridian achieved popularity as a reliable longitudinal reference through the Greenwich Observatory's high quality data. During the International Meridian Conference in Washington D.C., in October 1884, the Greenwich Meridian was declared the prime meridian and Greenwich Mean Time (GMT) became the world's time standard.

In 1972, Coordinated Universal Time (UTC) replaced GMT as the world's time standard; however, France did not formally use UTC as a reference to its standard time zone (UTC+1) until August in 1978.

Today, there are more than 24 time zones, since the International Date Line creates three more and several times zones are only 30 or 45 minutes apart.

Standard Time

Standard time is the local time in a country or region when Daylight Saving Time (DST) is not in use. More than 60 percent of the countries in the world use standard time all year.

Source: www.timeanddate.com

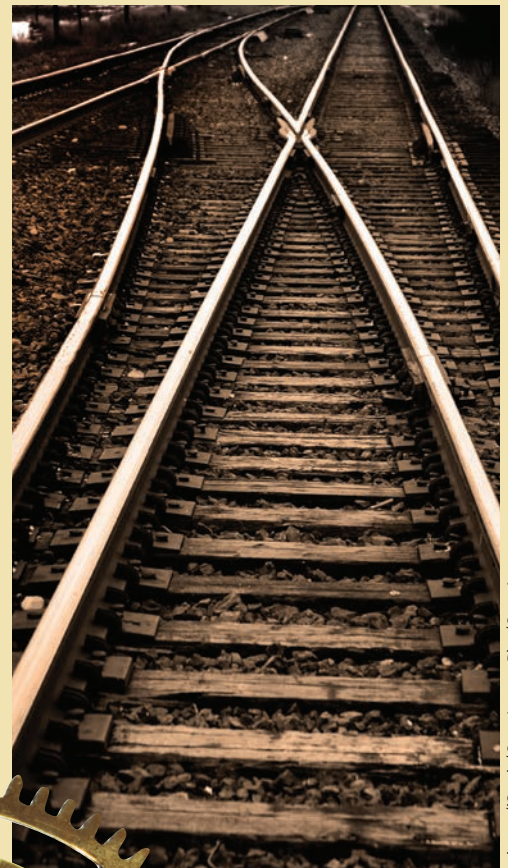

eric1513/iStock/Getty Images Plus/Getty Images



Gear: robas/E+/Getty Images

towers can 'handshake' and pass off your phone calls—is based on perfect timing.

“And then of course there is the precise synchronicity between satellites, which is the basis of global positioning systems (GPS),” says Lowe. “Most people don’t realize that GPS is a timing system that just broadcasts single times to single entities.”

“The truth is, the better we can disseminate the definition of one second, the better all these technological things work, and the more data we can send down any individual fiber. There really doesn’t seem to be an end to it. We build better clocks, and people find better uses for them.”

The NIST always knows exactly what time it is, and broadcasts it on shortwave via stations WWV in Colorado and WWVH in Hawaii. While hundreds of thousands of people used to call NIST to check for the



Clock In

The average U.S. city commuter loses 38 hours a year to traffic delays.

Source: Discover magazine

correct time, only about 10,000 people a year avail themselves today—no doubt because the call is no longer toll-free. (For those willing to pay the long distance cost, the number for those living outside Fort Collins, Colorado, is 303-499-7111.) The rest of us carry time with us in our cellphones, our dashboards, our bracelet watches and our memories.

“Each culture in history has a relationship with time that predates our modern era,” says Poirier. “I was raised by my mother that if I wasn’t

15 minutes early, I’m 15 minutes late.”

“I think it’s just the high-tech world that we live in,” says Lowe, whose own wristwatch is equipped with a radio receiver tuned to WWV. “Everybody feels that their own time usage is so important and that, in some cultures at least, the concept of being on time means, ‘We’re meeting at 2 o’clock so you’d better be there on time or I’m wasting my time waiting for you.’ Everybody thinks his time is so important. And I guess it is.”

Even Shakespeare grasped this, four centuries before our time.

“Friends,” he has Brutus say, over his brother-in-law’s body, “I owe more tears to this dead man than you shall see me pay. I shall find time, Cassius, I shall find time.”



Odometer: sergey_ksen/iStock/Getty Images Plus/Getty Images; Gear: Discovod/iStock/Getty Images Plus/Getty Image

Stay Safe with...

Dixon's Extensive Line of Hose Restraints



Our wide variety of hose restraints help solve your safety challenges by preventing injury to operators and damage to equipment.

Dixon's traditional steel or stainless steel Made in the US King Cable™, King™ Safety Whipsock or nylon King Cable™ all provide a positive safeguard for your hose connections.

In stock and ready to ship from Dixon, when and where you need them; why look elsewhere?

dixonvalve.com

Real solutions for real challenges.

877.963.4666 • dixonvalve.com •    

©2017 Dixon Valve. All rights reserved.



The Right Connection®



The Man Behind the Brand

DAVID OGILVY, THE TWEEDY, PIPE-SMOKING BRIT, BECAME THE “KING OF MADISON AVENUE.” BUT THE PRIMARY BRAND HE WAS SELLING WAS HIMSELF

BY DAVID HOLZEL

THE YOUNG BRITISH salesman had a tough assignment: selling high-end stoves known as Aga Cookers. It was London in the 1930s, and in his first time out, David Ogilvy was almost doomed to fail. A London club had installed the stoves but couldn't figure out how to work them. The club was ready to toss out its Agas and cancel the account.

Ogilvy arrived wearing a chef's uniform and went to the kitchen, where the mystified cooks could not figure out how to make pancakes. To demonstrate the ease with which the Aga could be operated, he fired it up, then poured batter into a frying pan and cooked one side.

“When it came time to turn the pancake over, he threw it high into the air ... put the frying pan behind his back, caught it flat in the pan,” writes biographer Kenneth Roman.

Ogilvy's flashy showmanship saved the account.

Even if the story didn't happen exactly that way—Ogilvy was known for never telling a story the same way twice—it is emblematic of the man who brought both theatricality and a hard-nosed business sense to Madison Avenue, ultimately earning him renown as “the father of advertising.”

Ogilvy & Mather, the New York advertising firm he founded, was a

boutique firm on shaky footing when he opened it in the 1940s. By the time he stepped down in the 1970s, it had become the fifth-largest advertising agency in the world.

Brashness and charm were Ogilvy's trademarks. But there were other things that set him apart. His advertising campaigns relied heavily on market research. He was a proponent of direct mail—a coupon with every ad. That way, a client had unassailable proof of how well his product was selling.

And he became known as the father of the soft sell, an approach he learned selling those Aga stoves. As Ogilvy put it: “The consumer is not a moron. She is your wife. Don't lie to her and don't insult her intelligence.”

Although born in England and identified as a Scot, Ogilvy made his mark on New York City's Madison Avenue: a tweed suit-wearing, pipe-smoking figure in the days of the man in the gray flannel suit, whose English accent gave him an air of sophistication that other “Mad Men” couldn't duplicate.

In an era when the idea of a brand wasn't yet well developed, Ogilvy realized that the most important brand to his business was himself.



Everett Collection/Newscom



Ogilvy's Long Prologue

He was born in 1911 in a rural village 30 miles southwest of London. His mother gave up a dream of a medical career to marry his father, a stockbroker, who lost everything at the onset of World War I.

His older brother, Francis, thought David was a genius and “opened doors for him at every key juncture,” writes Roman.

Young David was asthmatic, bad at sports and “too odd to be popular” at prep school in Edinburgh. He lasted two years at Oxford, before he went to Paris and found a job as a cook at the Majestic luxury hotel.

Francis Ogilvy headed the London advertising firm Mather & Crowther, and in 1935, he hired David, then 24, as a trainee. But America was calling. In 1938, David traveled there to study U.S. advertising techniques, then returned there to do market research with George Gallup in Hollywood, where Ogilvy discovered the importance of the youth market to movie sales. From his perch in the United States, he went to work for British military intelligence during World War II.

And at the age of 35, he bought a farm in Amish country in Lancaster,

“Only first and that in

Pennsylvania, where he rented the land to a farmer who grew cigar leaf tobacco.

In 1946, Mather & Crowther appointed Ogilvy their representative in the United States. Two years later, he sold the farm and moved to Connecticut, and with the major support of his brother’s firm and \$6,000 of his own money, he launched Hewitt, Ogilvy, Benson & Mather to assist British clients in doing business in the United States.

Now it began. One night he jumped off the train that was taking him home from Manhattan and called his office. “You won’t believe this,” he said, “but I’ve had an idea.”

He had come up with a novel way of advertising the beers of the venerable Guinness company to Americans: “The Guinness Guide to Oysters.” The idea was to “borrow interest for Guinness from the fascinating foods you drink it

with,” according to Roman.

Other successes soon followed: He pronounced Schweppes ginger ale and mixers as possessing “Schwepperversence,” a tagline that quickly caught on, and he dreamed up the horse and buggy delivering Pepperidge Farm baked goods.

Ogilvy’s overarching strategy for these and other campaigns: “You can’t bore people into buying your product. You can only interest them in buying it.”

An early proponent of the brand, Ogilvy was also building his own brand.

“Just as Hemingway was defined by his picture as well as his prose, Ogilvy’s look matched his words: effortless, smooth, proud and a bit scornful,” Michael Wolff wrote in *Adweek* in 2011, on the 100th anniversary of Ogilvy’s birth. “He not only looked the part, but looked like a movie star playing the part.”



class business, a first class way.”

Ogilvy's big ideas

In the 1980s, Ogilvy appeared on *The David Letterman Show* to plug his book *Ogilvy on Advertising*. A craggy, charming elder to Letterman's smooth-faced youth, Ogilvy talked about what he called the “big ideas” that animated his best advertising campaigns.

There was, for example, the man in the Hathaway shirt, his 1951 campaign to sell an obscure brand of men's dress shirt, which featured a model with an eye patch. “At that time, what was going through your mind that a man missing an eye would be a good idea to sell a shirt?” Letterman asked.

“If you can inject into the ad an element of story appeal ... people say, ‘Who is this man with the eye patch?’ That takes about a tenth of a second. And then people read the copy and that's how you sell the shirt.”

And it worked. After the first Hathaway ad appeared, every shirt the company had in stock was sold out. The ad entered the general culture. A cartoon in the *New Yorker* showed three identical button-down types walking into a men's store and emerging wearing identical eye patches.

There was the Rolls Royce ad with the headline: “At 60 mph the loudest noise from this new Rolls Royce comes from the electric clock.”

“When I presented this ad—they were all engineers,” Ogilvy said. “And the head man at Rolls Royce, very serious, he said, ‘We really must do something about that damned clock.’”

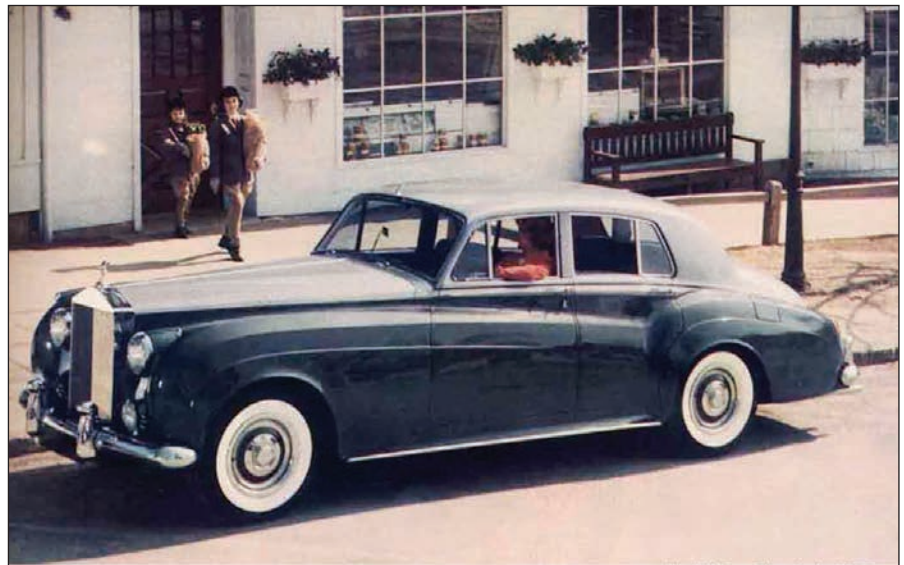

The Rolls-Royce Silver Cloud—\$13,995

“At 60 miles an hour the loudest noise in this new Rolls-Royce comes from the electric clock”

What makes Rolls-Royce the best car in the world? “There is really no magic about it—it is merely patient attention to detail,” says an eminent Rolls-Royce engineer.

1. “At 60 miles an hour the loudest noise comes from the electric clock,” reports the Technical Editor of *THE MOTOR*. Three mufflers tune out sound frequencies—acoustically.
2. Every Rolls-Royce engine is run for seven hours at full throttle before installation, and each car is test-driven for hundreds of miles over varying road surfaces.
3. The Rolls-Royce is designed as an *owner-driven* car. It is eighteen inches shorter than the largest domestic cars.
4. The car has power steering, power brakes and automatic gear-shift. It is very easy to drive and to park. No chauffeur required.
5. The finished car spends a week in the final test-shop, being fine-tuned. Here it is subjected to 98 separate ordeals. For example, the engineers use a *stethoscope* to listen for axle-whine.
6. The Rolls-Royce is guaranteed for three

years. With a new network of dealers and parts-depots from Coast to Coast, service is no problem.

7. The Rolls-Royce radiator has never changed, except that when Sir Henry Royce died in 1933 the monogram RR was changed from red to black.

8. The coachwork is given five coats of primer paint, and hand rubbed between each coat, before *nine* coats of finishing paint go on.

9. By moving a switch on the steering column, you can adjust the shock absorbers to suit road conditions.

10. A picnic table, veneered in French walnut, slides out from under the dash. Two more swing out behind the front seats.

11. You can get such optional extras as an Espresso coffee-making machine, a dictating machine, a bed, hot and cold water for washing, an electric razor or a telephone.

12. There are three separate systems of power brakes, two hydraulic and one mechanical. Damage to one system will not affect the others. The Rolls-Royce is a very *safe* car—and also a very *lively* car. It cruises serenely at eighty-five. Top speed is in excess of 100 m.p.h.

13. The Bentley is made by Rolls-Royce. Except for the radiators, they are identical motor cars, manufactured by the same engineers in the same works. People who feel diffident about driving a Rolls-Royce can buy a Bentley.

PRICE. The Rolls-Royce illustrated in this advertisement—*F.O.B.*, principal ports of entry—costs **\$13,995**.

If you would like the rewarding experience of driving a Rolls-Royce or Bentley, write or telephone to one of the dealers listed on the opposite page.

Rolls-Royce Inc., 10 Rockefeller Plaza, New York 20, N. Y., CIRele 5-1144.

March 1959

Ogilvy's Rolls-Royce ad (1958)

Printed with acknowledgement from Ogilvy & Mather and Rolls Royce

Ogilvy seemed to take as much delight in recounting his embarrassments, such as an early TV commercial for *Good Luck* margarine. It featured Eleanor Roosevelt, then widowed from President Franklin D. Roosevelt. “People remembered Mrs. Roosevelt, but they couldn’t remember the name of the margarine,” he told Letterman.

The experience reinforced one of Ogilvy’s rules of thumb: Don’t use celebrities in ads.

The 1950s were Ogilvy’s creative heyday. His copy-heavy, fact-filled ads ran in the *New Yorker*, where wealthy consumers would be sure to see them—a snob appeal Ogilvy cultivated.

He created a company culture in companywide memos, speeches and books. Before long, he exchanged the tweed jacket for a double-breasted blue blazer, lined in scarlet. When he stood to speak, he removed his

jacket, revealing red suspenders.

In the 1960s, his firm grew. There was an international merger, a public offering and big clients, such as the General Foods Maxwell House account, Shell Oil and American Express, whose tagline, “Don’t leave home without us,” still floats through the culture.

That phrase was the work of another copywriter. Ogilvy was now working primarily to land clients, and some of his half-hearted attempts at copy were real clunkers.

“What’s super duper about Super Shell?” was one contribution.

“For a short period of my life...I was close to being a genius,” he said. “Then it ran out.”

On a trip to France in 1966, Ogilvy found a chateau and bought it without telling his American wife. (She was his second wife. Ogilvy had three altogether.) When they broke up in 1973, Ogilvy kept the chateau and

retired there in 1975, after stepping down as chairman of Ogilvy & Mather.

David Ogilvy died in 1999 at the age of 88, leaving behind an international empire with billings that year of \$8 billion.

Today the company is one of the eight largest advertising networks in the world, with more than 450 offices in 169 cities. And the corporate culture that he defined for the company in “What We Believe and How We Behave,” part of his book *Confessions of an Advertising Man*, continues to guide operations. “Superior service to our clients depends on making the most of our people,” Ogilvy wrote. “Give them challenging opportunities, recognition for achievement, job enrichment and the maximum responsibility. Treat them as grown-ups—and they will grow up. Help them in difficulty. Be affectionate and human.”

Easily connect with... EZLink™ Cam & Groove



We’re improving your ability to transfer and unload fuels, water and other liquids in a big way.

With Dixon’s new armless positive locking system, simply push to connect the EZLink™ coupler to any standard cam & groove adapter for a reliable connection.

Our low-profile design means connecting in tight spaces and applications is easy. Top it off with low-maintenance durability, and you have today’s best way to transfer or unload liquids from tank trucks to storage facilities.

dixonvalve.com/EZLink

Real solutions for real challenges.

877.963.4666 • dixonvalve.com •    

©2017 Dixon Valve. All rights reserved.



The Right Connection®

Common Excellence • Uncommon Excellence • Uncommon Excellence • Uncommon Excellence • Uncommon Excellence • Uncommon Excellence • Uncommon Excellence • Uncommon Excellence

THE DIXON DRILLER

"Published once a moon since 1932"

WINTER 2017

To read The Dixon Driller on a monthly basis, visit our website:
dixonvalve.com

PRODUCT SPOTLIGHT

HTE-Series Quick Disconnects Connect Under Pressure

Applications:

- Ideal for hydraulic applications where connecting against residual pressure is required
- Ultimate solution anywhere trapped pressure is an issue

Sizes: 3/8" - 1"

Materials:

- Componentry: ROHS compliant zinc nickel plated steel
- Rings and pins: stainless steel

- Dust caps: nitrile
- Seals: nitrile/polyurethane

Features:

- Used in conjunction with Dixon® HT-Series, and other ISO16028, couplers
- Smooth connection action up to full working pressure
- Interchangeable with Parker FEC-Series, Stucchi APM-Series and Faster 3FFH-Series



Specifications:

- Connected with residual pressure in the nipple up to 5,000 PSI

For additional information, please call Dixon Quick Coupling at 1.877.963.4966, or visit dixonvalve.com.

Dates in History

1512: On November 1, the majestic ceiling frescoes adorning Rome's Sistine Chapel were unveiled to the public. Painted by a rising young sculptor named Michelangelo, they remain one of the Italian Renaissance's most iconic masterpieces, with 5 million neck-craning tourists peering at their beauty each year.

1666: On November 14, the first experimental blood transfusion took place in Britain, utilizing two dogs.

1763: Charles Mason and Jeremiah Dixon begin surveying the Mason-Dixon Line between Pennsylvania and Maryland on November 15 and finished four years later. It is still a demarcation line among four U.S. states, forming part of the borders of Pennsylvania, Maryland, Delaware and West Virginia (originally part of Virginia before 1863).

1792: Benjamin Banneker, mathematician and astronomer, was most famous for his widely published *Farmer's Almanac* (1792-1797), for which he calculated the daily locations of stars and planets and accurately forecast lunar and solar eclipses. His almanacs also included opinion pieces, literature, and medical and tidal information.

1956: The *Nat King Cole Show* debuted November 5th on NBC, the first variety program to be hosted by an African-American. The show ended about a year later on December 17, 1957, due to lack of national sponsorship.

onthisday.com

TRIVIA

Did you know that...

If you had \$1 million in one-cent coins—100 million of them—it would weigh 246 tons.

The first reference to "millionaire" appears in *Vivian Grey*, a novel written in 1826 by British author Benjamin Disraeli: "Were I the son of a millionaire, or a noble, I might have all."

The average bill is meant to take up to 4,000 folds in each direction before it rips. Why's it so strong? Currency paper is 25 percent linen, making it rip-resistant.

The Swedish 10-daler copper coins of 1644 weighed 43 pounds 7 ounces.

The Romanian 10-bani notes of 1917 had a printed area of just 1.6 by 1.5 inches.

In 1997, a total of 12,194,723,000 coins were minted in the U.S.

\$1 million in \$1 bills would weigh exactly 1 ton and if you put them in a pile, it would be 361 feet high.

The first coins were staters, minted in Lydia (now Turkey), from 680 to 645 B.C. Their value depended upon their weight.

Paper money was invented by the Chinese in the 10th century.

The Diners Club card issued in the U.S. in 1950 was the first credit card. It enabled the first 200 members to dine using credit at 27 New York restaurants.

\$1 million in \$100 bills would weigh only 22 pounds.

Salmon P. Chase, the 25th U.S. Secretary of the Treasury under Abraham Lincoln, was once featured on the U.S. \$10,000 bill.

The clock on Independence Hall found on the back of the U.S. \$100 bill reads 4:10.

Book of 1,001 Lists and Happyworker.com

ON THE LIGHTER SIDE

The checkout clerk at the supermarket was unusually cheerful even though it was near closing time. "You must have picked up a ton of groceries today," a customer said to the checker. "How can you stay so pleasant?"

"We can all count our blessings," the clerk replied. "The hardest part of this job is the turkeys and the watermelons. I just thank God that Thanksgiving doesn't come in July."

Dad rarely dresses up, so when he left the bedroom decked out in a suit and tie, he wanted to commemorate the moment. Handing me a camera, he asked, "Mind taking a selfie of me?"

I'm driving with this guy, and he runs right through a stop sign. So I say, "Hey, that was a stop sign." And he says, "I drive like my brother!"

A few blocks later, he plows right through a red light. I say, "You just ran a red light." And he says, "I drive like my brother!"

So now we're coming up on a green light, and he slows down. I'm confused, so I say, "It's green; why are you slowing down?"

He says, "My brother might be coming."

The water I was heating for pasta refused to boil, and if my 12-year-old son was right, I wasn't helping by constantly checking on it.

"It's like that old saying," he said. "A watched website never loads."

rd.com

Quirky and fun, this corner of the United States offers offbeat urban experiences and magnificent natural beauty

the Pacific Northwest

BY MARY K. ZAJAC

Glimpsed from an airplane, Oregon's Crater Lake shimmers, an otherworldly blue-black disc cupped between the peaks of an often-snowy mountainous landscape. At its widest, the lake spans 6 miles, but from this vantage point, it looks even larger. From the sky, you can't see Phantom Ship or Wizard Island, small landmasses that break the blue surface. Instead, the water appears sleek, seamless, serene.

The Pacific Northwest grabs you with these unexpected sights. Mountains tower just beyond city horizons. Massive outcroppings of rock punctuate Pacific waves just a few hundred feet from the sandy shore. Fertile land yields acres of fruit, and urban centers sprout buildings that climb high over the landscape.

Whether you're an outdoor enthusiast, fervent foodie or music-loving urban explorer, a trip to the Pacific Northwest—a region bounded by the Pacific Ocean on the west and the Rocky Mountains on the east—gives you the opportunity to retrace historic trails or blaze new ones.

Offbeat Portland

Begin your exploration of this corner of the United States in Oregon with a visit to Crater Lake National Park. Formed 7,700 years ago after a volcano first erupted and then collapsed, the 1,943-foot-deep freshwater lake (the deepest in the United States and



The Phantom Ship formation rises from the sleek waters of Oregon's Crater Lake, the deepest lake in the United States.

lighttouch/iStock / Getty Images Plus/Getty Images

Wizard Island, at the west end of Crater Lake, was so named by William Gladstone Steel, who felt it resembled a sorcerer's hat. Steel, the "Father of Crater Lake National Park," spent years lobbying for its national park status.



Clockwise from top: Portland skyline, Timberline Trail to Mount Hood, and Multnomah Falls—Oregon's tallest waterfall



zhufeng/istock/Getty Images Plus/Getty Images



freebilly/istock/Getty Images Plus/Getty Images



Kyle_Hittner/istock/Getty Images Plus/Getty Images



Portland is a haven for artists and creative professionals who take pride in the city's reputation for being quirky.



the ninth-deepest in the world) is fed exclusively by snow and rain. Driving around the lake's east end offers spectacular views of the lake itself: the volcanic spires of Pinnacles Road; Cloudcap Overlook, the highest point in Oregon reachable by paved road; and the coursing flow of water at Vidae Falls. The park also features hiking trails, a lodge and campground and a visitor's center. While the park is open year-round, a summer visit helps ensure that most roads will not be closed due to snowfall.

When you're ready for a little cosmopolitan life, make the four-hour drive north to Portland, population 634,000. Over the last 20 years, the city has become a haven for artists and creative professionals of all stripes and takes great pride in its slogan, "Keep Portland Weird." Gourmands will delight in the food and drink scene. Don't miss Paley's Place restaurant, the 2005 winner of the James Beard Foundation Award for Best Chef

Northwest, which features local and sustainable ingredients including Pacific halibut and salmon; the sweet indulgences of the 24-7 Voodoo Doughnut Shop; and the numerous coffee shops and brewpubs that seem to dot every corner.

Walk off your indulgences in Washington Park with a stroll through the International Rose Test Garden, which is celebrating its centennial in 2017. A guided tour (offered daily) will ensure you see many of the nearly 10,000 roses on-site, as well as dramatic views of the city far below. Once you've descended, be sure to visit Powell's City of Books—a must for anyone passionate about reading. Taking up an entire city block and made up of nine color-coded rooms containing over 1 million volumes, Powell's claims to be the world's largest independent new and used bookstore. They just may be right.

Portland is also a great central base for exploring the Pacific coast to the west and the Columbia River Gorge to the east. Drive along the canyon that was created where the Columbia River flows through the Cascade Mountains, and take in windsurfers among the river's white caps before stopping to see the jaw-dropping 611-foot-tall Multnomah

Gourmands will delight in Portland's food and drink scene. Don't miss Paley's Place restaurant, which features local and sustainable ingredients; the sweet indulgences of the 24-7 Voodoo Doughnut Shop; and the numerous coffee shops and brewpubs.



Laurie Carter Photography

Sampling of Paley's Place restaurant cuisine

Come up for air at Seattle's Pike Place Market, one of the nation's oldest continuously operating farmers markets, where you can indulge in anything from chocolate-covered Washington cherries to Dungeness crab.



Pioneer Square pergola in Seattle

Falls, Oregon's tallest waterfall. Trails and bridges allow visitors to see (and hear) the cascading waters up close. Linger over lunch at the Visitors Center or overnight at the Multnomah Falls Lodge before driving on to Mount Hood, Oregon's highest peak. At 11,245 feet, skiing is a year-round perk, and seasonal fishing and hiking are among its many lures.

About halfway between Portland and Seattle (a three-hour drive from city to city) is another of the region's majestic peaks: the 14,410-foot Mount Rainier. An active volcano, glacier-covered Mount Rainier is the birthplace

of six rivers and is a wilderness paradise for hiking and climbing. You'll discover woodland meadows or possibly spot an elk or the large, squirrel-like marmot in one of the many ecosystems that cohabit this national park.

Youthful Seattle

Eighty-five miles north of Mount Rainier lies Seattle. Home of Microsoft, Starbucks, Amazon and Boeing and the birthplace of '90s grunge rock (as well as music pioneers like Jimi Hendrix and Kurt Cobain), Seattle revels in being cutting-edge.

The majestic Mount Rainier is the birthplace of six rivers.





An aerial view of the Seattle skyline

Art Wager/Stock / Getty Images Plus/Getty Images

The iconic 1960s-era Space Needle embodies that image and has become a symbol of the city. Constructed for the 1962 World's Fair, the 605-foot-tall structure offers unparalleled views of the city, the waterfront and even Mount Rainier. Once you've taken in the view from on high, spend a few hours (or a day or two) strolling the Seattle Center campus below. The 74-acre community gathering spot features myriad fountains and gardens, outdoor

concerts and several museums (including the Pacific Science Center and the Museum of Pop Culture). When you're ready to eat, head for the Seattle Center Armory, a trendy food court offering fresh local fare.

About one mile south, a walk through Pioneer Square, Seattle's oldest neighborhood founded in 1852, is a window into Seattle's beginnings with its preserved Romanesque Revival architecture, while Underground

Tours reveal subterranean Seattle through passageways created after the Great Fire of 1889.

Come up for air at Seattle's Pike Place Market, one of the nation's oldest continuously operating farmers markets, where you can indulge in anything from chocolate-covered Washington cherries to Dungeness crab.

And of course, no visit to Seattle is complete without a stop at the Original



Friday Harbor in the San Juan Islands

Kschulze/Stock / Getty Images Plus/Getty Images

The San Juan Islands

For a completely different Pacific Northwest experience, consider an excursion to the San Juan Islands. Accessible by passenger ferry from downtown Seattle, the islands are part of a larger archipelago between the U.S. and Vancouver Island, British Columbia. With consistently 70-degree summer days, clear skies and a decidedly friendly vibe, the islands are a perfect place to unwind. Paddle a kayak in a local bay, cycle through the rural roads of Lopez Island, or walk the beach looking for eagles and lighthouses. The islands are famously home to a pod of orcas, and whale-watching excursions abound.



GarvisRP/Stock/Getty Images Plus/Getty Images



Tomwachs/Stock/Getty Images Plus/Getty Images

Oregon's Willamette Valley is home to over 700 wineries. Grapes thrive in the region's long, warm days and cool, crisp nights.

Wine Country

Both Oregon and Washington are leaders in the American wine industry. Oregon's Willamette Valley boasts over 700 wineries and excels in wine varieties like pinot noir, pinot gris and riesling, which thrive in the long, warm days and cool, crisp nights. Use McMinnville or Salem as your base to visit classic wineries like Ponzi, Argyle, Chehalem, Adelsheim and Penner-Ash.

Washington boasts the second-largest amount of wine production in the U.S., with over 50,000 acres stretching east of the Cascade Mountains and 14 American Viticultural Areas (or AVAs) including the Columbia, Yakima and Walla Walla Valleys. Washington's high latitude and long growing season are ideal for producing vinifera grapes like chardonnay and riesling and red varietals like syrah, merlot and cabernet sauvignon.

Medioimages/Photodisc/Photodisc/Getty Images



Seafood at Seattle's Pike Place Market

Starbucks, located on the corner of First and Pike at the gateway to the market. It's here that the first Starbucks opened in a narrow storefront, luring passersby by offering some of the world's finest fresh-roasted whole bean coffees. The rest, as they say, is history. ☛

The Sporting Side

Seattle and Portland are home to a wide variety of professional sports teams, which collectively draw hundreds of thousands of fans each year:

SEATTLE

- Seattle Mariners:** Major League Baseball
- Seattle Seahawks:** National Football League
- Seattle Sounders FC:** Major League Soccer
- Seattle Storm:** Women's National Basketball Association
- Seattle Reign FC:** National Women's Soccer League

PORTLAND

- Portland Trail Blazers:** National Basketball Association
- Portland Timbers:** Major League Soccer
- Portland Thorns FC:** National Women's Soccer League
- Portland Winterhawks:** Western Hockey League



litrib/E+/Getty Images

Avoid downtime with...

Boss Low Pressure System Products



Dixon's Boss LPS (Low Pressure System) products are used in many of the applications found at hydraulic fracturing sites from the water source up to high pressure pumps.

These one-piece products with **no-welds**, **no-threads** and **no-leaks** help you avoid costly downtime and enhance up-time!

dixonvalve.com/bosslps

Real **solutions** for real challenges.

877.963.4666 • dixonvalve.com • [f](#) [in](#) [yt](#) [ig](#)

©2017 Dixon Valve. All rights reserved.



The Right Connection®

The Crimean War

BY EUGENE FINERMAN

A catastrophic collision of forces in the mid-19th century helped modernize warfare by introducing the telegraph, modern nursing methods and more



Siege of Sevastopol, Crimean War, 1855



Photos.com/PHOTOS.com/Getty Images Plus/Getty Images

For centuries, Great Britain's mastery of the sea was a chief focus. For all its seeming audacity, the plan was actually feasible. The prosperity and protection of the world's greatest empire depended on that. But Britain also maintained a keen interest in the balance of power in Europe, and in the mid-19th century, a new threat arose to that balance: Russia.

The interests of imperial Russia were not defined by commerce and politics. No, Russia's policy was animated by a mystical sense of identity. The bastion of Orthodox Christianity and self-anointed champion of the Slavic people, Russia felt destined to free the Balkans and Constantinople from the Ottoman Turks. The Ottoman Empire was corrupt, decadent and odious, but it was no danger to British interests. But for the British, a Russian Empire that extended into the Mediterranean was cause for concern. An attack on Turkey would be an attack on Britain. Russia discovered that in 1853, in a catastrophic collision remembered as the Crimean War.

Wallachia and Moldavia, the area we know today as Romania, were Ottoman

provinces on the Russian border. The people were Orthodox Christians, so Russia felt entitled to liberate them. Turkish forces were heroic but incompetent; Russia's army was soon in Bucharest. The Romanians probably preferred the Russians to the Turks, but that was not Britain's concern. The status quo was, and Britain was prepared to prop up the collapsing Ottoman Empire. So was France. France's foreign policy reflected the ambitions and insecurities of its new emperor, Louis Napoleon. Looking back on two centuries of French defeats, especially his uncle's (the empire-building Napoleon Bonaparte ultimately fell from power after launching an invasion of Russia in the summer of 1812), this Bonaparte decided it was far wiser to be England's ally than its foe.

In case the Russians entertained any plan to cross the Danube and liberate Bulgaria, the British fleet sailed into the Black Sea and a French army landed in Varna, Bulgaria. That dissuaded the Russian crusade. In fact, Russia withdrew her forces from Romania. The status quo seemed restored, but Britain was not so easily satisfied. Russia had to

As an affront to Russian pride and proof of their power, the British and French would invade Crimea and seize Sevastopol. Though definitely a bold move, the plan had potential.

be humiliated, and the allies imagined a brilliant way to do it. The Russians had just one naval base on the Black Sea: the Crimean port of Sevastopol. As an affront to Russian pride and proof of their power, the British and French would invade Crimea and seize Sevastopol.

Though definitely a bold move, the plan had potential. The British navy controlled the Black Sea. Crimea, a peninsula, could be cut off from the



Major battles of the Crimean War

continuous bombardment. Perhaps to their surprise, the allies found themselves in more miserable circumstances than the 80,000 besieged Russian troops. The siege of Sevastopol would last a year. But the British and French had made no plans for a long campaign, let alone a siege. No provision had been made for a Russian winter: not warm clothing, fuel or shelter. The allies eventually supplied their men with tents and huts, but not before thousands died of illness and exposure.

Of course, the Russians made repeated attempts to break the siege. One of their few victories was actually a British blunder: the Charge of the Light Brigade. Responding to the Russian attack, a British commander led his cavalry in the wrong direction, charging a formidable and irrelevant Russian position. The brigade had 700 men; only 195 returned. Viewing the superb horsemanship and the pointless attack, a French general said, "It is magnificent, but it is not war."

Worse for the British, the calamity was quickly publicized. Journalists had accompanied the army and, with access

mainland. The Russian army was poorly equipped, armed with muskets against the allies' rifles. Lacking railroads, Russia could not easily reinforce or supply its forces in the Crimea. So the allies expected to land in Crimea and quickly take Sevastopol. On Sept. 14, 1854, their invasion began, a force of 50,000 men landing north of the port. Some 30,000 Russian soldiers awaited them ... and were routed. Moving on to

Sevastopol, the allied generals soon realized that a quick capture of the city was not realistic. Besieging Sevastopol seemed more prudent.

The allies started digging in, encircling the city with 75 miles of trenches. Reinforcements brought their total to 175,000 men. Warfare at the time still adhered to a certain chivalry; civilians were permitted to evacuate the city before Sevastopol was subjected to

Siege of Sevastopol, Crimean War, 1855



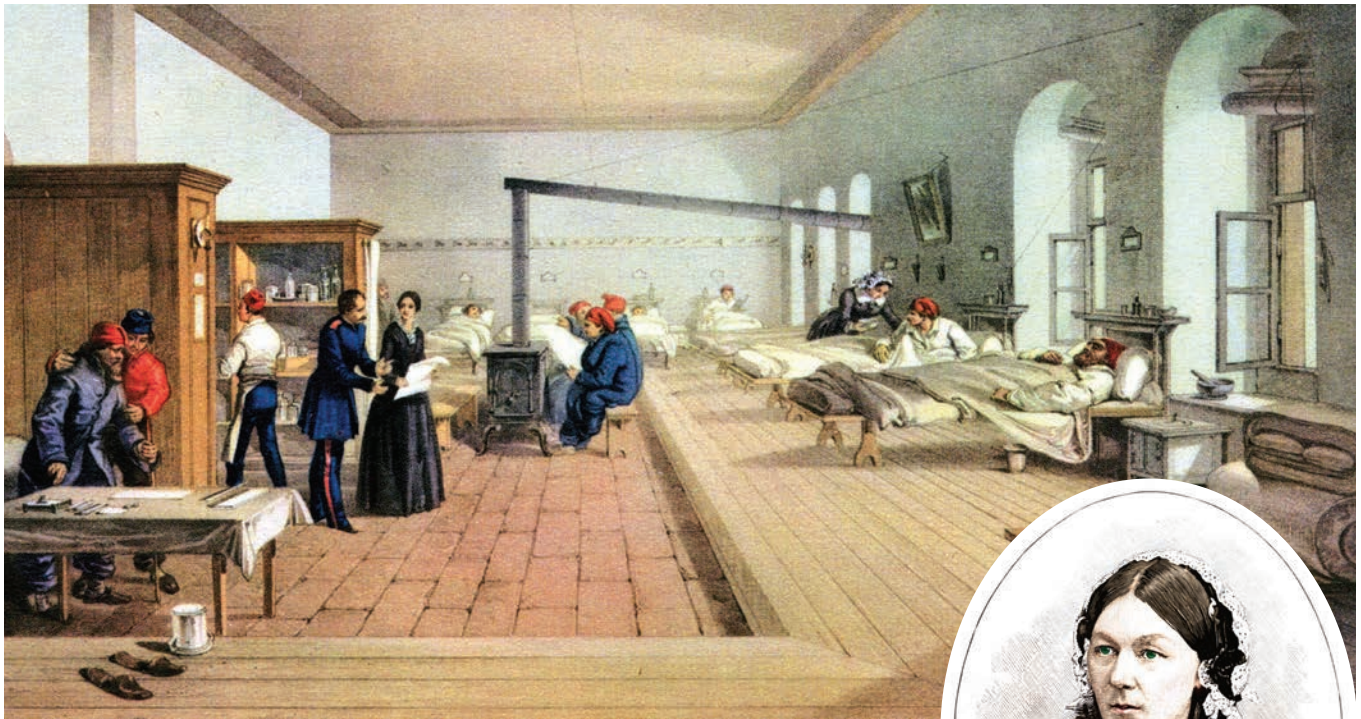

Florence Nightingale inspecting hospital ward during the Crimean War



Florence Nightingale, "the lady with the lamp"

to telegraphs, could transmit their stories. A courier would carry the dispatches on a boat, a day's voyage from Crimea to Varna, Bulgaria, where the French had established a telegraph line. From there, the news could be sent to Paris and London. So, three days after the Charge of the Light Brigade, Londoners could read the dismaying details in their morning newspapers. By the autumn of 1855, with a 310-mile-long cable under the Black Sea, the telegraph line extended to Crimea.

While "the thin red line" of infantry remained heroes, those men faced far worse adversity than Cossack cavalry: incompetent officers, inadequate supplies and appalling medical care. If a soldier was wounded on the battlefield or sickened in the squalid camps, he first had to survive a 300-mile voyage on the Black Sea to the Barracks Hospital in Scutari, Turkey. Awaiting him were conditions of filth and neglect that Florence Nightingale described as "the Kingdom of Hell." The Barracks Hospital had a mortality rate of 52 percent. No battle was as deadly.

Responding to the public outrage, the British government sponsored a nursing mission to Barracks Hospital.

A group of 38 nurses was led by Florence Nightingale. Until Miss Nightingale, nursing was not a vocation but a joke. However, the need for methodical care of the sick was real, and the young British heiress made it her life's work. Studying health care abroad, she returned to England to practice nursing and train others who shared her dedication. She arrived at Barracks Hospital and reported the scandalous squalor: "a washing once in 80 days for 2,300 men. The consequences of all this are fever, cholera, gangrene. ..." She and her nurses instituted and maintained a standard of care: bathing the sick, laundering their clothes and bedsheets, ensuring regular and healthy meals. Nightingale seemed tireless. Supervising the wards through the night, she came to be known as "the lady with the lamp." Thanks to her and her nurses, the mortality rate at the Barracks Hospital declined to 20 percent.

Sevastopol finally fell in September 1855. The war did not officially end until March 1856. By the terms of the Treaty of Paris, the status quo was reestablished. Turkey still had nominal control of Romania, although the region

was ceded autonomy. Otherwise, 500,000 Russian troops had died for nothing and Russia's economy was left in ruins.

At least the British army, which had lost only about 21,000 troops, was willing to learn from the Crimean War. The requirements for officers would now be more than just social standing. There would be staff colleges for training them. Anyone above the rank of captain actually had to earn it. Finally, there was an acknowledgment of the heroism and sacrifice of the enlisted men. On June 26, 1857, Queen Victoria thanked and honored 62 veterans of the Crimean War with a medal "for gallantry in the face of the enemy." The medal, cast from captured Russian cannons, was—and remains—the highest award that Britain could bestow upon a person in her armed forces: the Victoria Cross. ◀

Dixon HTE: A Smooth Solution



David Murphy, Dixon Territory Sales Manager

> IN DAVID MURPHY'S JOB

at Dixon as a territory sales manager, he routinely makes calls to industrial rental houses and construction companies. Many of these companies use skid steers that require the use of multiple attachments in a day's service.

"When I speak with shop mechanics at these places, they all seem to encounter the same problem when changing attachments on their equipment," says Murphy. "They all have stories to share with me about cracking a hydraulic line or beating the plug with a hammer or screwdriver to bleed off the pressure. And rental houses share their frustration on having

"When I speak with shop mechanics at these places, they all seem to encounter the same problem when changing attachments on their equipment," says Murphy.



Flush Face Female plug HTE3F4 and Flush Face Female plug HTE4F4.
Dixon HTE products are manufactured in the U.S.A.

to send out a technician to a home or job site to help the inexperienced operator connect a new attachment."

Fortunately, Murphy knows he has a solution for their connection frustrations: the Dixon HTE. Made

of solid steel bar stock, it provides smooth connection action and non-linear connection force at all pressures.

Those working in the field recognize the value of the Dixon HTE the minute Murphy gives them a demo, he says. He recalls one memorable sales call to a Sunbelt Rental location in Baltimore, Maryland. As he was walking through the shop yard to meet with the head of maintenance, he saw an employee on a skid steer fighting to attach an auger. Murphy walked over and asked the man if he could share a solution.

The employee's curiosity was piqued. "Why not?" he replied. So Murphy opened his demo case, showed him the Dixon HTE and how it works, and suggested the maintenance worker give it a try. He did, and it bowled him over: "You mean to tell me this is available and I won't have to fight to make this connection anymore?" he said to Murphy, shaking his head.

Before long, two other maintenance employees arrived to watch and to try their hand at using the Dixon HTE. They were so impressed, says Murphy, they got on their walkie-talkies and invited their colleagues to join the group. "Shortly thereafter," says Murphy,

"every technician and the head of maintenance was gathered around the table, eager to get hands-on with the demo kit and to feel the ease of connection under pressure. Needless to say, the call was fun, and resulted in a purchase order for several plugs for the initial order."

In addition to welcoming a solution for their immediate problem, most clients recognize the long-term return on investment of Dixon's HTE plug. "When they have a failure in the field with a standard HT plug, due to beating the plug up to relieve pressure, that results in equipment being down, loss of productivity and

time spent driving to the nearest shop to buy a new coupler," says Murphy. By converting to the Dixon HTE plug, companies eliminate costly down time—and many headaches.

"Selling is fun," concludes Murphy. "But I find that selling solutions to our customers' problems is not only fun but rewarding." ■

HOW CAN DIXON HELP YOU?

For more information, visit www.dixonvalve.com or call (877) 963-4966.

HTE Series Hydraulic Quick Disconnects



Designed for use where connecting against residual pressure is required. Largely used in the construction equipment market, these fittings are the ultimate solution anywhere trapped pressure is an issue

Our HTE series has full interchangeability with other popular brands allowing you to easily replace fittings without customization.

dixonvalve.com

Real **solutions** for real challenges.

877.963.4666 • dixonvalve.com • [f](#) [in](#) [yt](#) [ig](#)

©2017 Dixon Valve. All rights reserved.



The Right Connection®

A World of Pain

Migraines are common and often excruciating—but promising treatments are on the horizon



g-stockstudio/Stock /Getty Images Plus

> EVER EXPERIENCED A HEADACHE

so debilitating that you couldn't get out of bed? If it ended up being a migraine, you're not alone: An estimated 37 million people in the United States suffer from these powerful headaches, and migraine is the third most prevalent illness in the world, according to the Migraine Research Foundation.

Evidence of migraines in humans dates as far back as the ancient Egyptians in 1200 B.C., though we've come a long way in identifying and treating them since then. Today we know that migraines are usually more severe than other types of headache, like sinus or tension headaches, and they are frequently described as pounding or throbbing, with pain often on one side of the head.

The side effects that may accompany migraines are often as bad as the headache itself: nausea or vomiting,

sensitivity to light or sound, blurred vision, lightheadedness. Attacks can last between four to 36 hours if untreated. While some people may suffer a migraine only occasionally, those unlucky souls with chronic daily migraine have at least 15 migraine days per month.

Migraines are often genetic. If you have a parent who suffers from them, you have a 50 percent chance of developing them at some point in life, says Jessica Ailani, a board-certified neurologist and director of the MedStar Georgetown Headache Center. In addition, migraines are three times more common in women than in men, according to the National Institute of Neurological Disorders and Stroke (NINDS).

While the root causes of migraine are a bit of a mystery, researchers believe that these brain-splitting

Botox: A Treatment for Migraines?

Most people are familiar with Botox, or botulinum toxin type A, being used as a cosmetic solution for wrinkles and frown lines. Now the FDA has approved it as a treatment for adults who experience migraines at least 15 days per month. Head and neck injections are given every 12 weeks or so to dull future headache symptoms. Results may last up to three months.

headaches may be the result of fundamental abnormalities caused by genetic mutations at work in the brain, according to NINDS.

The first signs of a migraine may occur hours to a full day ahead of an attack. You may feel unusually energetic or depressed, irritable, thirsty, hungry for specific foods, sleepy, or like you need to urinate more often.

About 20 percent of migraine sufferers will also experience what's called an aura up to one hour before a migraine—a warning sign that trouble is on the horizon. This neurological symptom can cause someone to see bright dots, like a camera flash, or colorful, zigzagging lines. Numbness or tingling on one side of the body can occur, too, but that doesn't happen to most people.

TREATMENT

Treating migraines often takes more than just over-the-counter pain medications, though they can help relieve mild migraines in some people. "Migraines are a serious disease of the nervous system," says Ailani. "They are

lifelong and often disabling, and can get better or worse over time.”

The good news is there are many ways to shorten a migraine’s duration once it begins. The most common “abortive” treatments are taken during a migraine and are aimed at stopping symptoms. Such treatments include a class of medications called triptans, which make blood vessels constrict and block pain pathways in the brain. Triptans can be taken by pill, nasal spray or injection.

Other options are nonsteroidal anti-inflammatory drugs, or NSAIDs, such as ibuprofen or naproxen. Anti-emetics, which can relieve nausea and vomiting, can help, too.

Look for new abortive options in the next two to three years, says Ailani. A new class of drugs that blocks the activity of a molecule called calcitonin gene-related peptide, which spikes during migraine attacks, is showing potential in clinical trials. CGRP is “the best validated target for migraine, ever,” says David Dodick, a neurologist at the Mayo Clinic in Phoenix.

If you have frequent migraines, meaning more than four days per month, you may be prescribed daily preventive medications. A new category of preventives shows a lot of promise, says Ailani. “These medications are the first preventive agents that have been specifically created to prevent migraines. They will be coming to market between 2018 and 2020.”

In addition, the U.S. Food and Drug Administration has approved a device known as Cefaly as a first-line treatment for frequent migraine sufferers. Affixed externally to the forehead, Cefaly delivers precise micro-pulses to the

upper branch of the brain’s trigeminal nerve to prevent future migraine attacks.

AVOIDING TRIGGERS

If you’re prone to migraines, there are a few lifestyle modifications that can help decrease their frequency. Don’t skip meals and make sure you’re getting enough sleep, managing stress, exercising regularly and limiting alcohol intake. These triggers are often layered and make you more vulnerable to an attack. “If something stressful happens and then you don’t sleep well for one or

two nights, you’re more likely to get a migraine,” warns Ailani.

If you do experience a migraine, try supplementing abortive medications with lots of rest in a dark, quiet room. Using an ice pack can also help.

Think you check all the boxes for having migraines? See your primary care provider first, says Ailani. He or she may refer you to a neurologist or headache specialist. “A migraine is a diagnosis made by a physician after ruling out other conditions,” she says. ■

SYMPTOMS : P-O-U-N-D-ING PAIN



PULSATING PAIN



ONE DAY SEVERE



UNILATERAL



NAUSEA OR VOMITING



DISABLING INTENSITY

SELF TREATMENTS



SCHEDULED EATING



AVOID TRIGGER



DRINK ENOUGH

Falara/iStock/Getty Images Plus/Getty Images

COMMON TRIGGERS

MSG

NITRATE

CHOCOLATE

CAFFEINE

ALCOHOL

CHEESE

OVER SLEEPING

STRESS

Falara/iStock/Getty Images Plus/Getty Images

Transformational Technology

Barely 50 years old, the internet has become an indispensable platform for global communication and commerce

> **FOR ALL ITS LORE**, one myth about the internet persists: that it arose because the military wanted data communications networks guaranteed to survive a nuclear holocaust. While certainly compelling and even factually accurate to a point, the internet's antecedents are traceable instead to a much more benign source: psychologist-turned-computer-scientist J.C.R. Licklider and his

seminal 1963 memorandum, "The Intergalactic Computer Network."

Licklider's vision was much more utilitarian—perhaps even utopian—than the doomsday narrative would have it. He was simply interested in ways humans could communicate better, and he was an unabashed proponent of computers.

The Armageddon myth likely stems from the saga of Paul Baran, a researcher for the Rand Corporation, who was working on a similar and near-simultaneous research trajectory

for the Air Force. One of his reports, 1964's "On Distributed Communications Networks," looked at how the military could shield electronic communications systems from catastrophic failure.

Baran's imagined solution called for a multipoint redundant



J.C.R. Licklider

network without identifiable central command and control. In the event of attack or breakdown, any surviving points on the network could reestablish contact. The network was failsafe.

Shrouded in military secrecy and excluded from the scientific press, Baran's work never materialized. Licklider, on the other hand, became head of a little-known group within the Advanced Research Project Agency—or



ARPA, for short—at the Department of Defense. (The D for “Defense” was added later, making it the familiar DARPA.)

While there, Licklider met Robert Taylor, then of NASA, who would soon join him at ARPA to build the ARPANet, recognized today as the true precursor of the internet. In 1968, Licklider and Taylor issued the bold promise: “In a few years, men will be able to communicate more effectively through a machine than face to face.”

To Baran’s credit, his work championed “redundancy of connectivity” and a technical approach now known as packet switching. These principles would become the cornerstones of data transfer and the internet’s now-famous resilience.

In packet switching, each digitized message—an email, a document, an image, an audio or video recording—is broken into smaller parts, known as packets. Each packet includes a piece of the original message and a header with information about who sent it, where it is going and where the packet fits among its legions of brethren packets from the original. It is like mailing a jigsaw puzzle one piece at a time.

When one party hits “Send,” the packets are dispatched to the network, free to follow the path of least resistance. No two packets are likely to follow the same route. If one gets lost, the receiving computer simply requests another. Better yet, if any computer in the network is down, busy or, worse, under attack, the packets just seek out a new path. It’s a beautifully elegant, beautifully simple design that is fast, efficient and strong.

ARPANet became the first network to run the Transmission Control Protocol/Internet Protocol—or TCP/IP—the technical infrastructure still in use today. So fundamental is TCP/IP that its inventors, Bob Kahn and Vint Cerf, still share the title of “Fathers of the Internet.”

THE RAPID RISE OF THE INTERNET

DATE	# OF USERS	WORLD POPULATION	INFORMATION SOURCE
Dec., 1995	16 millions	0.40%	IDC
Dec., 1998	147 millions	3.60%	C.I. Almanac
Dec., 1999	248 millions	4.10%	Nua Ltd.
July, 2000	359 millions	5.90%	Nua Ltd.
Aug., 2001	513 millions	8.60%	Nua Ltd.
July, 2002	569 millions	9.10%	Internet World Stats
Sept., 2002	587 millions	9.40%	Internet World Stats
Sept., 2003	677 millions	10.60%	Internet World Stats
Feb., 2004	745 millions	11.50%	Internet World Stats
Dec., 2004	817 millions	12.70%	Internet World Stats
Nov., 2005	972 millions	15.20%	Internet World Stats
Dec., 2006	1,093 millions	16.70%	Internet World Stats
Mar., 2007	1,129 millions	17.20%	Internet World Stats
Dec., 2007	1,319 millions	20.00%	Internet World Stats
Jun., 2008	1,463 millions	21.90%	Internet World Stats
Sept., 2008	1,504 millions	22.50%	Internet World Stats
Jun., 2009	1,669 millions	24.70%	Internet World Stats
Dec., 2009	1,802 millions	26.60%	Internet World Stats
Jun., 2010	1,966 millions	28.70%	Internet World Stats
Dec., 2011	2,267 millions	32.70%	Internet World Stats
Dec., 2012	2,497 millions	35.70%	I.T.U.
Dec., 2014	3,079 millions	42.40%	Internet World Stats
Dec., 2015	3,366 millions	46.40%	Internet World Stats
Jun., 2016	3,631 millions	49.50%	Internet World Stats
Mar., 2017	3,739 millions	49.60%	Internet World Stats
Jun., 2017	3,885 millions	51.70%	Internet World Stats

Source: <http://www.internetworldstats.com/emarketing.htm>

Licklider and Taylor issued the bold promise: “In a few years, men will be able to communicate more effectively through a machine than face to face.”



Robert Taylor

MERI SIMON/KRT/Newscom

What transpired over the next half-century remains one of the transformational technology stories of human history. The first email traversed the ARPANet in 1971. The World Wide Web was imagined in the 1980s and ushered in hypertext and the practice of linking between documents. In the 1990s, Mosaic introduced the graphical browser and the web became an indispensable platform for global communication, entertainment and commerce. ●

U.S. President George W. Bush presents the 2005 Medal of Freedom to Internet inventors Vinton Cerf (L) and Robert Kahn (R) during a ceremony at the White House November 9, 2005 in Washington, D.C.



Mark Wilson/Getty Images

Cover all your applications with... **Dixon's Reusable Hose Fittings**



Designed for use where a durable hose connection is required or where an easy repair is a must.

Dixon's reusable hose fittings feature heavy duty construction, are rated to working pressures up to 250 PSI and are recommended for use only on rubber hose. They are available in high quality CDA 360 brass and 303 stainless steel (select sizes only).

With over 110 fittings available, our selection is sure to cover all your application needs!

dixonvalve.com

Real **solutions** for real challenges.

877.963.4666 • dixonvalve.com •    

©2017 Dixon Valve. All rights reserved.



The Right Connection®

Common Excellence • Uncommon Excellence • Uncommon Excellence • Uncommon Excellence • Uncommon Excellence • Uncommon Excellence • Uncommon Excellence

Real solutions for real challenges.

It's true that we have a broad product line available "anytime anywhere" to meet your everyday needs.

But we also design and manufacture just the right solutions to meet those special fluid transfer challenges where a standard product just won't do.

The difference boils down to commitment. It's called *Uncommon Excellence™* – and we've been living it for over a century.



The Right Connection®



ADS Portable Overfill Detection

Are product spills making a mess of your bottom line? ADS portable overfill detection alarms are a low cost solution!

Automated Design Service, Inc. (ADS) is now operating as Dixon® Industrial Fluid Control manufacturing products specifically designed for liquid terminal operations. Our standard product offering includes Outalarms, Spillguard™ monitors, probes and cables.

Visit dixonvalve.com/ads to learn more.



Uncommon Excellence • Uncommon Excellence • Uncommon Excellence • Uncommon Excellence • Uncommon Excellence • Uncommon Excellence • Uncommon Excellence • Uncommon Excellence • Uncommon Excellence • Uncommon Excellence



From figuring it out to getting it done, we're here to help.

Bring us your problems. Your challenges. Your just about anything. Because we're not just in the shipping business, we're in the problem solving business. It doesn't matter if you're a big company or you're just you, we'll help make it happen. We're 400,000 people around the world serving more than 220 countries and territories, ready to roll up our sleeves and get to work. So bring us your ideas, your questions, your boldest business plans yet. ups.com/solvers



ups united problem solvers™

Copyright ©2015 United Parcel Service of America, Inc.